

# OEM Manual (EN)

Version UMT/WG T-BT OEM rev. 1.0 date 08/04/2019



---

(pagina libera / empty page)

---

---

# Manual Guide

POINT 1-2 > **INTRODUCTION & SAFETY**

POINT 3-6 > **UNIT DESCRIPTION**

POINT 7 > **COMMISSIONING**

POINT 8 > **SOFTWARE – USER INTERFACE**

POINT 9 > **SERIAL COMMUNICATIONS**

POINT 10 > **MAINTENANCE**

POINT 11-13> **ALARMS AND TROUBLES**

POINT 14-21> **TECHNICAL DATA**

## Contents

1	Introduction .....	5
2	Safety issues with CO <sub>2</sub> - Safe handling .....	5
2.1	Precaution.....	5
3	Unit description & Main components.....	7
4	Unit installation .....	8
5	Piping details .....	9
5.1	Pipe Connections (Multi-Split) .....	9
5.2	Oil traps.....	9
6	Test and inspection before start-up .....	10
6.1	Control of the unit tightness.....	10
6.2	Preliminary controls according to EN 60204-1, visual controls.....	10
6.3	Management of the system. Configuration of the controllers.....	10
6.4	Inspection of the water loop.....	11
6.5	Earth connection.....	11
7	Commissioning.....	12
7.1	Evacuation and pre-charge.....	12
7.1.1	“VACUUM”, SW function details.....	12
7.2	Refrigerant & Oil Charging.....	13
7.2.1	Oil charge.....	13
7.2.2	Procedure for additional oil refill.....	13
7.2.3	Estimation of the refrigerant charge.....	13
7.2.4	Charging procedure.....	15
8	User Interface and main Software features.....	16
8.1	User Interface.....	16
8.2	On/Off unit.....	17
8.3	Regulation set point.....	18
8.4	MPXPRO and ULTRACELLA/EVO CAREL configuration. ....	19
8.5	MPXPRO and ULTRACELLA/EVO CAREL regulation.....	20
9	Serial Communication (PSD drivers, Evaporators and Supervisory System).....	21
9.1	Communication with evaporators (features and requirements).....	21
9.2	Serial connections and wirings.....	22
10	Recommended Annual Checks.....	23
11	List of alarms .....	24
11.1	Hecu alarm.....	24
11.2	PSD (Power+) alarm code.....	30
11.3	PSD led status.....	32
12	Troubleshooting.....	33
13	Compressor Envelope .....	34
14	Refrigerant drawing (P&I).....	35
15	HECU Controller layout .....	36
16	Terminals blocks connection .....	37
17	Dimensional drawing.....	37
18	General information and limits .....	38
19	Electrical details.....	38
20	Cooling capacity Table.....	39
21	Conversion pressure-temperature CO <sub>2</sub> (R744).....	41
22	Note .....	42

## 1 Introduction

CUBO<sub>2</sub> AQUA is an high efficiency condensing unit (for CO<sub>2</sub> transcritical application) equipped with BLDC variable speed compressor. It is compact, easy to install and can directly communicate with the refrigerated units.

Thanks to these features it is a very efficient (even at partial load) without any compromise with the food conservation.

This manual refers to CUBO<sub>2</sub> AQUA models designed for cooling and conservation at low temperatures. They are identified as:

UMT/WG T 030 BT DX	UMT/WG T 045 BT DX	UMT/WG T 067 BT DX
--------------------	--------------------	--------------------

## 2 Safety issues with CO<sub>2</sub> - Safe handling

When the R744 (CO<sub>2</sub>) is being handled, a qualified person must be present with the suitable equipment. CO<sub>2</sub> has no smell or colour and the operator would not be aware if there were any leaks. The effects of increased CO<sub>2</sub> levels on adults at good health can be summarized:

CO <sub>2</sub> concentration		Effects
%	ppm	
0,04 %	< 400	Normal outdoor level
0,06 %	< 600	Acceptable levels
0,50 %	5000	8hours - Long Term Exposure Limit
1,5 %	15.000	15 minute - Short Term Exposure Limit.
3 %	30.000	Intoxicating, breathing and pulse rate increase, nausea.
10 %	100.000	Inconscious, further exposure death.
30 %	300.000	Quick death.

### 2.1 Precaution

- Dedicated pressure relief valves are necessary in all those sections of the system which can be isolated by shut valves. Due to the high thermal coefficient of expansion of liquid CO<sub>2</sub>, fluid pipes must not be blocked.
- All SCM units are protected against overpressure with pressure relief valves when required according to EN378 and PED.
- Given the high pressure that system can reach during operation, special attention must be paid to connect and regulate the unit.
- Before carrying out any repairs which involve breaking into the system/soldering or welding, all relevant parts must be emptied of CO<sub>2</sub>.
- Do not use other than the designated refrigerant (for charging, adding or recharging)
- Refrigerant gas leak may cause suffocation.
- Piping, equipment components and tools should be appropriate for use with R744 (CO<sub>2</sub> refrigerant).

- ☑ Use of unsuitable components or those designed for HFC refrigerant may cause serious incidents such as equipment failure and rupture of the refrigerant cycle.
- ☑ Securely place the cover on the electrical box and enclosure panel. Incomplete attachment may lead to penetration of water and living creatures, meaning potential current leak and fire/electrical shock.
- ☑ Do not change the set values of the safety device.
- ☑ Using the refrigeration unit with changed values may cause failure of the safety stop function and lead to a burst or fire.
- ☑ When abnormal operation is detected, or before starting disassembly or repair, turn off the main power switch.
- ☑ Specified components must be used for repair.
- ☑ Use of non-specified components may cause failure of the safety stop function and lead to burst or fire.
- ☑ Incorrect moving may cause falling or dropping of the refrigeration unit, and cause injury.
- ☑ Request a specialty operator for disposing the refrigeration unit.
- ☑ Make sure that access and emergency exit ways are not obstructed to comply with the local regulations.

### 3 Unit description & Main components

Low temperature condensing unit is equipped with 2 BLDC compressors having the same size. They work as in a booster system. One compressor is taking in charge the evaporation pressure control for the low temperature refrigerated devices. The other one (PARALLEL) is controlling the pressure in the receiver. No flash valve is installed in this unit.

The system operates at the following pressures:

Parallel Compressor discharge pressure (PGC) : operating between 45-105 bar.

Parallel Compressor suction pressure/Receiver pressure PREC : operating between 32-60 bar.

LT suction pressure : operating between 12-18 bar.

Compressor modulation range: 25 – 100 rps

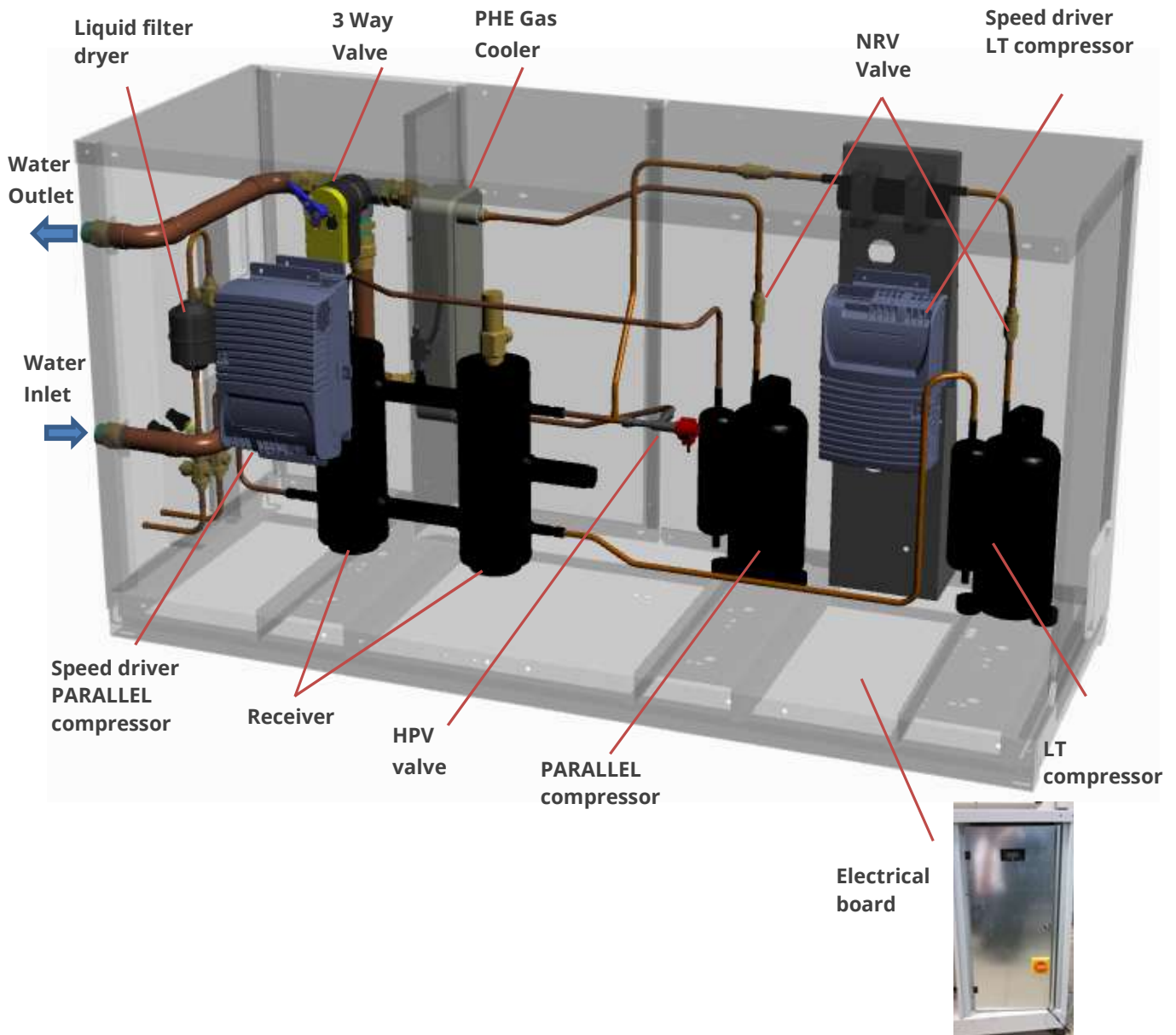

## 4 Unit installation

- ☑ The unit has been designed for outdoor installation.
- ☑ Respect distances for correct operation/ maintenance.
- ☑ In the case of several units in series or in parallel mode, respect the minimum distances for properly maintenance.

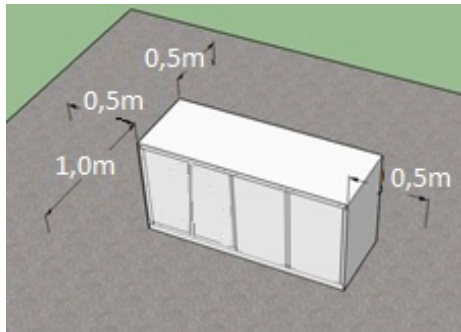

*Minimum maintenance distances.*

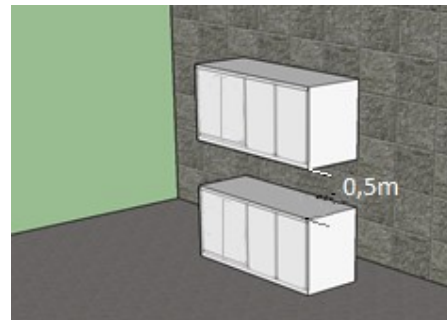

*Vertical installation*

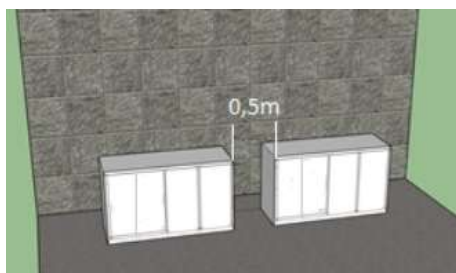

*Horizontal installation*



## 5 Piping details

### 5.1 Pipe Connections (Multi-Split)

The recommended connection between the Condensing Unit and more remote evaporators is the same one used for Multi-Split system.

Basically the system requires a dedicated suction line for each evaporator that will be collected by a manifold installed close to the condensing unit. Please refer to the example reported in the below picture.

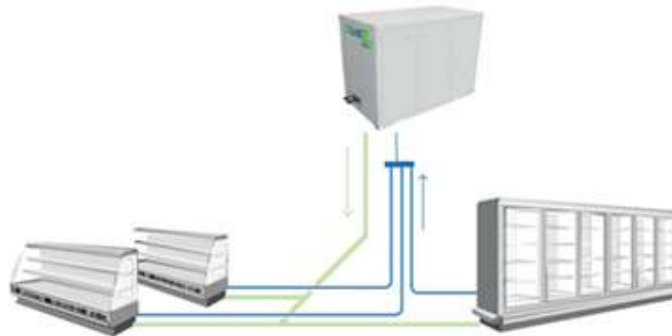

- **PRO:** good compromise solution between oil return and pressure drop issue can be found.
  - **CONS:** higher copper pipe usage but with smaller diameters, easier installation.
- ☑ The collector must be properly sized and installed in a horizontal position
  - ☑ **SCM Frigo recommends connection with up to 3 remote evaporators, and maximum suction pipe length of 20 meters to each evaporator.**
  - ☑ Liquid line must be properly sized to supply the farther evaporators (liquid velocity < 1 m/s is suggested). Suction line must be properly sized to have a good oil return with a low pressure drop (gas velocity from 8 to 16 m/s are suggested).

### 5.2 Oil traps

- ☑ If UMTT and evaporator are installed at different heights, it is necessary to create piping oil traps. The installation of an oil-trap is recommended (one oil-trap every 2/3 meters of difference in height)

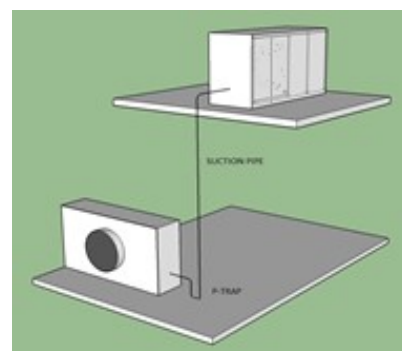
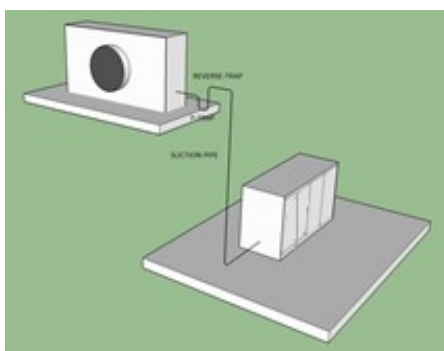

## 6 Test and inspection before start-up

### 6.1 Control of the unit tightness

All units are pressure tested and checked for leaks.

Each unit is delivered with a nitrogen charge pressure of 2 bar.

It is recommended before proceeding with the installation, to check the pressure of the refrigeration system of the unit using a suitable manifold gauge in order to detect possible leaks.

### 6.2 Preliminary controls according to EN 60204-1, visual controls

1. General PE terminal present and identified.
2. All other terminals clearly identified, with the ground symbol or two-colour yellow-green lead.
3. Terminals for exclusive connection to the equipotential connections.
4. Only one lead connected to each terminal.
5. Yellow/green insulation on the ground lead.
6. No live leads with yellow or green insulation.
7. No pipes or raceways used as lead protections.
8. No fuses, switches or circuit breakers on the equipotential protection circuit.
9. Lead sizes conform to the minimum sizes given by current standards.
10. Check the electric connections have been made correctly. Especially the phase connections: open the box with the compressor terminal block, the connections must conform to the diagram given in the compressor electric box.

### 6.3 Management of the system. Configuration of the controllers

The unit is equipped with the controller Carel prackCO<sub>2</sub> Hecu, which is managing the working parameters as following

- BT compressor is managed according to suction pressure
- 3way valve to modulate the water flow in the PHE Gas cooler is managed to keep the gas cooler outlet temperature few degrees above the water inlet temperature
- Gas cooler pressure is managed according to the gas cooler outlet temperature in order to achieve the best COP
- Receiver pressure is regulated with a floating set-point within a user defined range (32-38 bar)
- All alarms related to compressor and pressure levels are monitored

**Refer to electrical diagram and controller configuration list, attached to this manual, to check the configuration.**

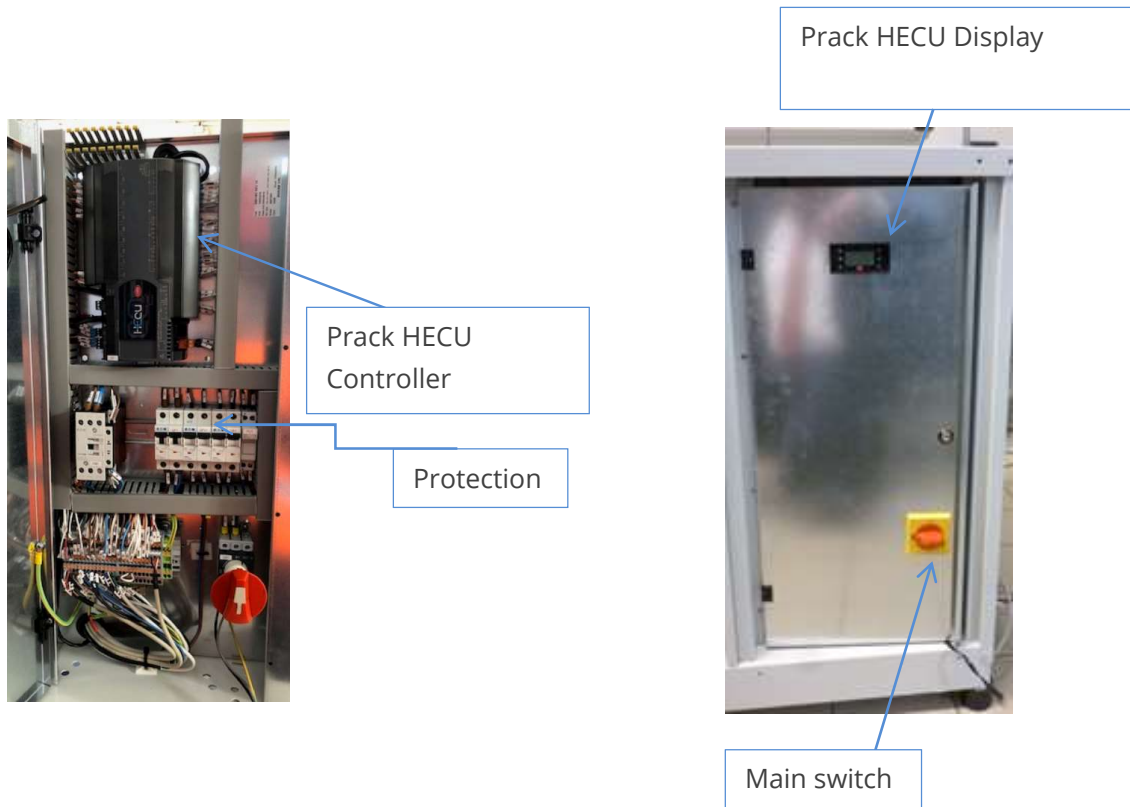

## 6.4 Inspection of the water loop

The cooling of the discharge gas coming from the compressor is occurring inside the PHE Gas Cooler. The PHE installed in the CUBO<sub>2</sub> AQUA is a Gas-Water heat exchanger and the water flow is controlled by a 3Way Modulating Valve according to the Gas Cooler outlet temperature.

Before switching on the condensing unit, it is important to be sure that the water loop side is operating properly (both the circulation and water temperature).

Suggested Water Inlet temperature (in the GC PHE) range is +7°C - +37°C.

## 6.5 Earth connection

The unit must be connected to the ground line, using the terminal provided by the constructor before the unit is turned on for the first time after installation. The customer is responsible for the connection and the efficient grounding in conformity with current legislation in force and for periodically checking the state of the same.

## 7 Commissioning

The unit leaves the factory without being filled with refrigerant.

The compressor and receiver are pre-charged with oil.

The customer is responsible for charging the system with CO<sub>2</sub> and adding more oil (**only if strictly necessary**).

The instruction given herein are a reminder of the best method to protect the unit, which could be seriously damaged in the event it is not filled correctly.

### 7.1 Evacuation and pre-charge



EEVMAG0000

- Before starting the vacuum procedure, it is necessary to open the high pressure valve (HPV) and the compressor equalization valves.  
**To open the valves a software based function (VACUUM) is available in the Cubo2 AQUA SW (find below some details).**  
 As an alternative you can open the valves manually. HPV valve can be opened with the Carel magnetic tools supplied with unit. (See photo on side). The magnet opening & closing direction is marked on the top – Clockwise to Open.
- Evacuate the system from both the high and low side condensing unit service connections.
- Stop the Vacuum procedure only when the “standing vacuum pressure” reach a value of 0.67mbar. During the vacuum process brake the vacuum several time with dry nitrogen.
- Before starting refrigerant charge, break vacuum WITH ONLY CO<sub>2</sub> VAPOUR (all parts of circuit) up to 10bar pressure to avoid dry-ice production.
- Do not switch on the compressor during this phase!

#### 7.1.1 “VACUUM”, SW function details

This function can be activated only while the unit is in OFF (regulation OFF) and the target is to automatically open HPV and Compressors equalization solenoid valves.

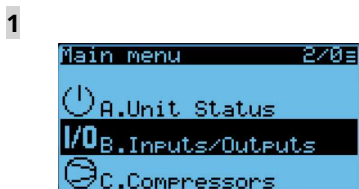

Main menu – Inputs & outputs

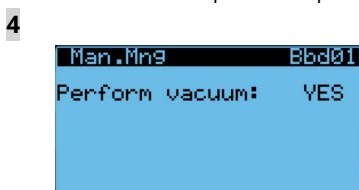

Select “YES” – This will then open HPV and equalization valve according to the settings in mask Bbd02

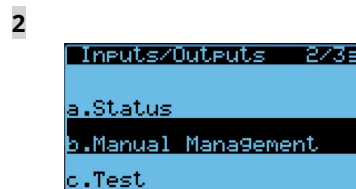

Manual Management

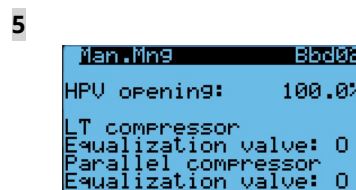

Set the wanted valves status during the Vacuum  
O = Open / C = Close

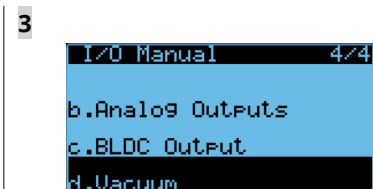

Vacuum

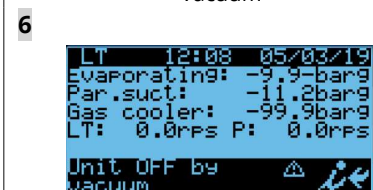

The status on the front screen will now indicate “Unit OFF by vacuum”, in this state the CDU cannot be set in ON. The above step should be reversed prior to charging the unit

## 7.2 Refrigerant & Oil Charging

### 7.2.1 Oil charge



- ✓ All CUBO<sub>2</sub> AQUA are equipped by SCM with an additional pre-charged of 250ml of Oil (type PAG VG100) in the receiver. This info is highlighted with a label applied in the switch panel door.



- ✓ Take care to avoid moisture ingress. PAG oil is extremely hygroscopic! Oil type approved is DAPHNE PZ100S or RENISO PAG100.

### 7.2.2 Procedure for additional oil refill

1. Close valve 1 (89 on circuit diagram)
2. Stop the unit (switch off)
3. Vent gas at valve 1 until pressure drops to 0 bar g (check on display)  
Internal check valve (138 on circuit diagram) will prevent emptying the whole circuit.
4. Charge 125 ml oil at valve 1 – use a manual stirrup pump
5. Evacuate from valve 1 & isolate manifold
6. Slowly open valve 1 & remove manifold when pressure is above 10 bar g
7. Wait for 5 min
8. Re start the unit
9. After 20 min, repeat the procedure to add remaining oil (125 ml)

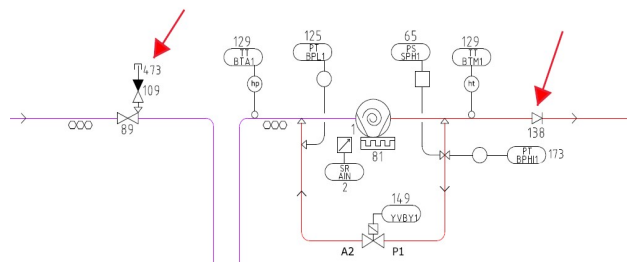

### 7.2.3 Estimation of the refrigerant charge

To get an estimation of total refrigerant quantity to charge in the system you should know:

- Volume of evaporator coil
- Diameter and Length of the piping

The total charge of refrigerant will be the obtained summing up the single quantity needed for the evaporator and for fill the liquid line (refer to the below example).



Regardless from the estimation results, the **minimum recommended CO<sub>2</sub> charged is 4kg**.  
For estimation greater than 4kg the quantity of charged CO<sub>2</sub> must be the estimated one.

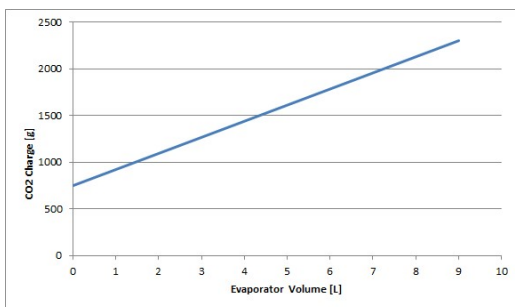

Using this diagram you can calculate refrigerant charge related to the evaporator inner volume.

You can apply also the following formula:  
 $Y \text{ (CO}_2 \text{ charge)} = 172,2222 * X \text{ (Evap.Volume)} + 750$

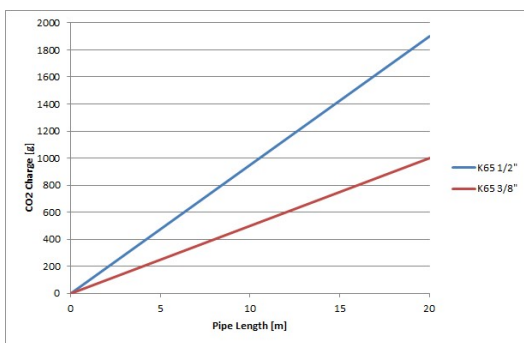

Using this diagram you can calculate refrigerant charge related to the pipe diameter and length.

You can apply also the following formula:  
 $(\text{CO}_2 \text{ charge}) = 50 * X \text{ (Pipe Length K65 3/8")}$   
 $Y \text{ (CO}_2 \text{ charge)} = 95 * X \text{ (Pipe Length K65 1/2")}$

	Length [m]													
Liquid line	5	6	7	8	9	10	11	12	13	14	15	16	17	18
K65 - 3/8"(gr)	250	300	350	400	450	500	550	600	650	700	750	800	850	900
K65 - 1/2' (gr)	475	570	665	760	855	950	1045	1140	1235	1330	1425	1520	1615	1710

### Examples of estimated refrigerant charge calculation

#### ***Example 1***

- Evaporator volume: 9lt.  
CO<sub>2</sub> charge calculated the first diagram is: 2300 gr.
- Piping length: 18mt for K65 3/8".  
CO<sub>2</sub> charge calculated form the second diagram: 900 gr.

Total refrigerant charge (estimated): 2300 gr + 900 gr = 3200 gr (< 4000gr).

**Total refrigerant to charge is 4000gr.**

#### ***Example 2***

In case that the evaporating volume is unknown, it is possible to estimate CO<sub>2</sub> charge considering only the pipe length and summing up 2,4 lt (= 2400 gr).

- Piping length: 20mt for K65 1/2".  
CO<sub>2</sub> charge calculated using the second diagram: 1900 gr.

Total refrigerant charge (estimated): 1900 gr + 2400 gr = 4300 gr (> **4000gr**).  
**Total refrigerant to charge is 4300gr.**



Don't overfeed the unit with excessive charge to avoid compressor damaged.

### 7.2.4 Charging procedure

- For charging, use port 1/4SAE (7/16"-20UNF) on service valve

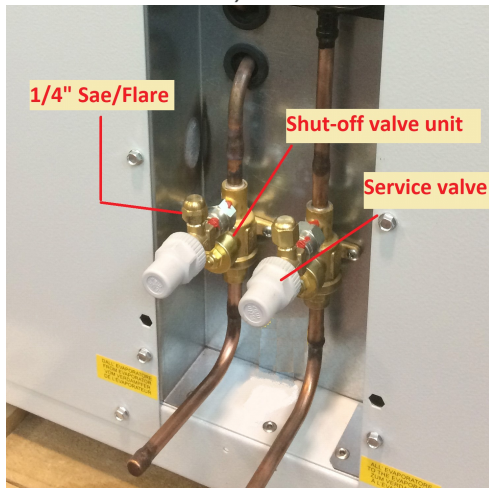

(PS120bar - CASTEL 6110E/X15)

#### Important remarks about the CO<sub>2</sub> charging procedure:

- CO<sub>2</sub> of purity class of N4.0 or comparable or with moisture content <10 ppm must be used.
- Charge R744 vapour into the system to a pressure of 10 bar g then liquid charge into the liquid line service port until you have charged the amount specified by the charge estimator.
- Charge CO<sub>2</sub> liquid only from liquid line.
- Charge CO<sub>2</sub> gas only from suction line.
- Never charge CO<sub>2</sub> liquid from suction to prevent the breakdown of the compressor.
- You should top up to achieve a ¾ sight glass, in the liquid receiver, when unit is running. A liquid overfeed can compromise correct regulation of the unit and the reliability of the compressor (liquid return).
- Always check liquid level in different condition, especially in transcritical and defrosting mode.
- Do not mix CO<sub>2</sub> with various other refrigerants.

## 8 User Interface and main Software features

### 8.1 User Interface

Manufacturer PW: 1234

Button meaning		Display meaning
	<b>1</b> Shows active alarms list and accesses to the alarm log. <u>If pressed for more than 5 sec., resets all acknowledged alarms.</u>	<b>A</b> Active alarm preset and manual operation.
	<b>2</b> Used to enter main mask tree.	<b>B</b> Unit status.
	<b>3</b> Return to back mask or higher level.	<b>C</b> Rotation speed of compressor (rps)
	<b>4</b> Scroll a list upwards or increases the value highlighted by the cursor.	<b>D</b> Current Time and date.
	<b>5</b> Scroll a list downwards or decreases the value highlighted by the cursor.	<b>E</b> Operation Suction pressure (bar).
	<b>6</b> Enters in the selected submenu or confirms the changed set values.	<b>F</b> Outlet Gas Cooler pressure (bar).
Led color and meaning		
	Red / blinking	Active alarm and not acknowledged Steady : alarms acknowledged
	Yellow / Fixed	Controller activated
	Green / Fixed	Controller powered



## 8.2 On/Off unit

Even if the unit is powered, it will stay in stand-by (regulation OFF) until the user turns-on the regulation (regulation ON).

The main steps to switch ON the regulation are reported here below:

From main menu, press “Enter” button and appear access with password (see A mask).

Note.

1/0

Current mask / total masks. The horizontal rows mean access level

Hc01

Letters and numbers are the name of mask.



Set password (default: 1234) and press “Enter”.



Select “Unit Status” and press “Enter”.

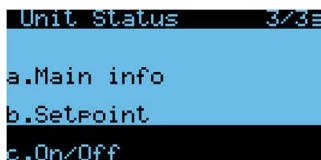

Select “On/off” and press “Enter”



Press “Enter”, to change from off to ON



Press “Enter”, to change from on to OFF.

### 8.3 Regulation set point

```
Main menu 3/03
C.Compressors
D.Condensers
E.Evaporator
```

Select "Compressor" and press "Enter"

```
Compressors 2/73
a.I/O status
b.Regulation
c.Working hours
```

Select "Regulation" and press "Enter"

```
Comp.Regul. Cab01
Regulation mode:
PRESSURE
Regulation type:
FIXED SETP.
```

If there are no serial communication between the CDU and the remote evaporators, compressor will be managed with a fixed setpoint.

```
Comp.Regul. Cab03
Setpoint:
12.0barg
```

Suction set point request.

```
Comp.Regul. Cab14
PID press. regulation
Differential:: 4.0barg
Integral time: 80sec
```

P+I regulation mode.

```
Comp.Regul. Cab01
Regulation mode:
PRESSURE
Regulation type:
FLOATING SETP.
```

In case of remote evaporators enabled, regulation type switch automatically from fixed point to floating setpoint

```
Comp.Regul. Cab02
Setpoint limits
Minimum: 11.0barg
Maximum: 14.5barg
```

Min. and max. setpoint variation admitted.

- ☑ **The above values are the factory settings and can be modified only from specialized people.**
- ☑ **The factory settings doesn't include the evaporator management.**
- ☑ **With the standard factory setting the unit will work based on a fixed suction set-point.**

## 8.4 MPXPRO and ULTRACELLA/EVO CAREL configuration.

- When unit is connected to evaporator controller via RS485, regulation type switch automatically from fixed to floating set-point.

```
Main menu 5/08
C.Compressors
D.Condensers
E.Evaporator
```

Select "Evaporator" and press "Enter"

```
Evaporator 2/48
a.I/O status
b.Configuration
c.Regulation
```

Select "Configuration" and press "Enter"

```
Store Conf19. Eab00
Ev.1 type:MPX PRO
Ev.2 type:MPX PRO
Ev.3 type:MPX PRO
Ev.4 type:ULTRACELLA
Ev.5 type:ULTRACELLA
```

Type of controllers connected to the CDU

```
Store Conf19. Eab01
N. of evaporators:5
[ ] Ev.1: not conn. 300W
[ ] Ev.2: not conn. 1200W
[ ] Ev.3: not conn. 1200W
[ ] Ev.4: not conn. 2300W
[ ] Ev.5: not conn. 2300W
Set default conf.: NO
```

Number of evap. and capacity of each unit

- It is important to set the right serial address for each evaporator installed, with following sequence:
- 11 - 12 - 13 - 14 - 15.**
- Different sequences and address not allowed!
- Set of effective cooling capacity in order to maximize the result of energy savings with floating suction regulation and in case of defrost

```
Store Conf19. Eab02
Device number: 1
Bus address: 11
Enable device: YES
Description: SKIP
U1
```

Basic information for each evaporator.

"Description": name of refrigerated units

```
Store Conf19. Eab03
1:U1
On/Off device: OFF
Lights: OFF
```

Start/Stop (On/Off) of evaporating management and light, if present

```
Store Conf19. Eab04
1:U1
Real time clock:
sync with CDU
DD: 3 mm:12 VV:17
Day of week: 1
HH:11 MM:42
```

Setting real clock for history alarm list

```
Evap. Config. Eab26
Device number: 4
Bus address: 14
Enable device: YES
Description:
Cbbiaaaaaaaaaaaa
```

```
Evap. Config. Eab27
4:Cbbiaaaaaaaaaaaa
On/Off device: OFF
```

```
Evap. Config. Eab31
5:Cccaaaaaaaaaaaaa
Real time clock:
sync with CDU
DD: 3 mm:12 YY:17
HH:10 MM:52
```

Connection to ULTRACELLA

### 8.5 MPXPRO and ULTRACELLA/EVO CAREL regulation

```
Main menu 5/0E
C.Compressors
D.Condensers
+E.Evaporator
```

```
Evaporator 3/4E
a.I/O status
b.Configuration
c.Regulation
```

```
Store Mn9 Eac01
1:U1
St -Reg.setp.: 2.0°C
rd -Diff.setp.: 20.0°C
PLt: 0.0°C
PHs: 9.0K
```

```
Store Mn9 Eac02
1:U1
P3 -SH setpoint: 8.0K
P4 -SH Gain: 8.0K
P5 -SH Integral: 350s
P6 -SH Derivat.: 0.0s
P7 -LSH Thresh.: 3.0K
```

```
Store Mn9 Eac03
1:U1
Smooth lines: ENABLED
PSP: 5.0K
PSI: 120.0sec
PSD: 0.0sec
```

```
Store Mn9 Eac04
1:U1
Evaporat.Power : 300W
Initial valve position
at startup : 30%
time after defr.:10min
```

Select “Evaporator” and press “Enter”.

Select “Regulation” and press “Enter”.

St	Regulation setpoint
Rd	Differential
PLt	Offset, below the setpoint, to switch off the regulation (Smooth Lines)
PHs	Maximum superheat offset (Smooth Lines)

P3	Superheat setpoint
P4	Control valve: Proportional gain
P5	Control valve: Integral time
P6	Control valve: Derivative time
P7	Low Superheat threshold

PSP	Smooth Line: Proportional gain
PSI	Smooth Line: Integral time
PSD	Smooth Line: Derivative time

## 9 Serial Communication (PSD drivers, Evaporators and Supervisory System)

### 9.1 Communication with evaporators (features and requirements)

CUBO<sub>2</sub> AQUA condensing unit is managed by HECU controller (Carel).

In case the controllers used to manage the refrigerated units are Carel (MPXPRO or ULTRACELLA), they can be connected via RS485 serial line to the HECU.

The main benefits coming from this serial communication between condensing unit and evaporators are:

- ☑ *Optimized oil management with “Oil washing function”*
- ☑ *Optimized suction pressure regulation by using “Floating Setpoint”.*
- ☑ *Evaporator setup and monitoring directly by Cubo2 AQUA user interface.*

The communication between condensing unit and evaporators controller is allowed only with some specific model of controllers (MPXPRO or ULTRACELLA) equipped with a specific software version. Please, refer to the below tables to check the compatibility.

#### MPXPRO

CUBO <sub>2</sub> AQUA SW version (Hecu)	MPXPRO SW version	Compatible for serial communication (YES/NO)	
		Type of electronic expansion valve	
		EXV Carel	PWM or Tev
2.1.362 or previous	3.3 or higher	YES	NO
2.1.662	3.3 or higher	YES	NO
<b>3.0.12</b>	3.3 or higher	YES	NO

#### ULTRACELLA

CUBO <sub>2</sub> AQUA SW version (Hecu)	ULTRACELLA SW version	Compatible for serial communication (YES/NO)	
		EXV driver model	
		EVD Evo (SW version 5.6 or higher)	EVDice
2.1.362 or previous	Any version	NO	NO
2.1.662	1.9 - 2.0	YES	NO
	<b>2.1</b>	YES	NO
<b>3.0.12</b>	1.9 - 2.0	YES	NO
	<b>2.1</b>	YES	YES

## 9.2 Serial connections and wirings

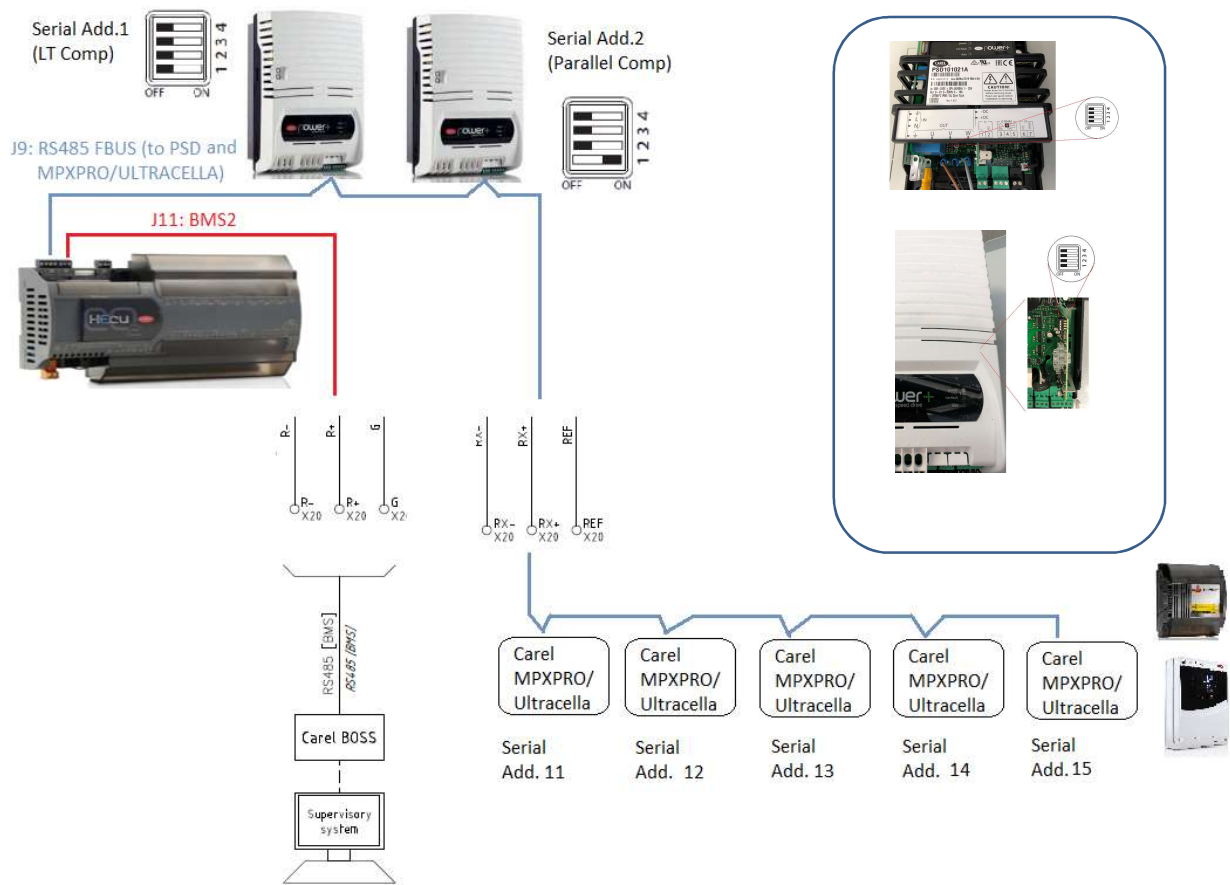

### MPXPRO/ULTRACELLA connector to use for the serial connection with HECU (RX-, RX+, REF)

Carel Controller	Connection Port	Note
MPXPRO		Terminals: GND, Tx/Rx+, Tx/Rx-  Modbus, 19200bps
ULTRACELLA		<b>BMS</b> Terminals 52, 53, 54  Modbus, 19200bps

## 10 Recommended Annual Checks

These checks should be carried out in conjunction with the customers' requirements.

<b>Compressor and Inverter Check</b>	
<p>The compressor should be inspected:</p> <ul style="list-style-type: none"> <li>- unusual sounds</li> <li>- unusual vibrations</li> <li>- excessive temperature of the shell</li> </ul>	<ul style="list-style-type: none"> <li>• Check tightness of all electrical terminals.</li> <li>• Check compressor bolting to the base</li> <li>• Control compressor running current is within compressor data</li> <li>• Check the temperature of the body to detect possible lack of lubrication. Top up oil if necessary</li> </ul>
<b>Pressure vessels</b>	
<p>All vessels should be inspected as per local laws and customers' requirements</p>	<ul style="list-style-type: none"> <li>• Inspect insulation for damage and repair as necessary</li> <li>• Investigate for any signs of corrosion</li> <li>• Investigate for any presence of leaks</li> </ul>
<b>Liquid drier</b>	
<p>Liquid drier filter should be replaced every 2 years</p>	<ul style="list-style-type: none"> <li>• Check temperature drop across the filter</li> </ul>
<b>Pressure switch and Pressure Relief Valve</b>	
<p>High pressure switch must be checked to ensure the safe operation of the unit.</p> <p>Check the PRV valve is up to date</p>	<ul style="list-style-type: none"> <li>• Test the correct cut out of the HP pressure switch to ensure activation and reset at correct pressure</li> <li>• Functionality of the electrical circuits must be verified at this point</li> <li>• The PRVs must be tested for refrigerant tightness and replaced as per manufacturers guidelines or customers' requirements</li> </ul>
<b>Unit operation</b>	
<p>The operation of the unit should be checked to detect faults in the controller, valves or sensors.</p> <p>Consult alarm logs</p>	<ul style="list-style-type: none"> <li>• Check operation of HP &amp; MP valves</li> <li>• Check calibration of temperature probes and pressure transducers</li> <li>• Check alarm logs for present and past alarms investigate and correct as necessary</li> </ul>
<b>General overview</b>	
<p>A general inspection should be carried out</p>	<ul style="list-style-type: none"> <li>• Carry out a full system leak test</li> <li>• Repair any missing or broken insulation</li> <li>• Check functionality of all electrical components</li> <li>• Check functionality of pack anti-vibration mounts</li> <li>• Check all pipework and supports</li> <li>• Ensure all valve caps and electrical guards are present.</li> </ul>

## 11 List of alarms

When an alarm occurs in the controller the alarm icon in the user display will be switched ON and it will start to blink (  ).

To get more alarm details you should check the alarm masks available in the display.

These mask contains several information (date and time, description, suct. and disch. Pressure, codes) that could help the user to identify the possible alarm reason and to understand which checks to perform.

Here below some details about how to interpret the different codes shown in the alarm masks.

- Highlighted in **RED** the main alarm reference → Check the HECU alarm table to get more details
- Highlighted in **BLUE** the PSD (POWER+) alarm code → Check the PSD (Power+) alarm table to get more details
- Highlighted in **GREEN** the Envelope Zone that caused a compressor shut-off → Check the Envelope Zone table to get more details (at page 34)

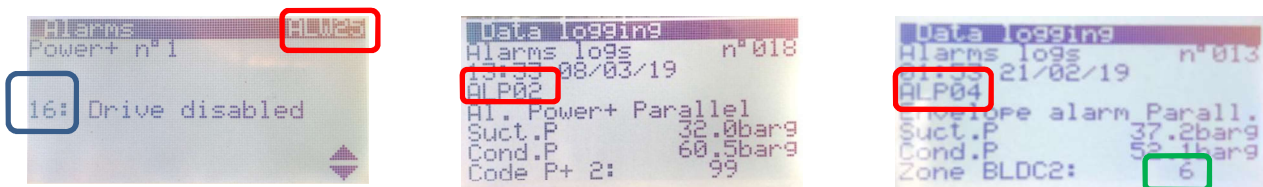

### 11.1 Hecu alarm

In the below table we reported a quick description about the Condensing Unit alarm with the main action made by the controller.

The alarm Index to refer is the one reported in the alarm masks or in the alarm logs (please find an example in the below picture. The Mask Index is the one highlighted in red).

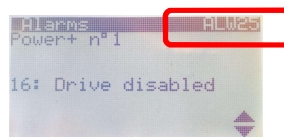

Mask index	Topic	Description	Serious alarm	Normal alarm	Action	Delay	Reset
ALU02	PROBES	Regulation probes missing. One of the main probe is missing or wrong configured: P_suc, P_GC, T_out_GC, P_receiver or Pparallel_Suct	x		Shutdown Unit	No delay	Automatic
ALA01		Discharge temperature probe broken or disconnected. Discharge temperature probe could be broken, disconnected or not properly configured		x	No action on the regulation The function that reduce the compressor speed to prevent High Discharge temperature will be disabled (mask Hb02 and Hb03)	No delay	Automatic



Mask index	Topic	Description	Serious alarm	Normal alarm	Action	Delay	Reset
ALA02		Gas cooler pressure probe broken or disconnected. Gas cooler pressure probe broken, disconnected or not properly configured		x	No action on the regulation The opening of HPV valve will be fixed at a safety value settable in mask Fhb13	No delay	Automatic
ALA03		External temperature probe broken or disconnected. External temperature probe could be broken, disconnected or not properly configured		x	All Functions managed by this probe will be disabled: - Floating Condensing setpoint - auto-switch of regulation on T_ext in case of T_outlet_GC is fault (mask Dag14) - speed up opening of gas cooler 3-Way valve according to T_ext (mask Dag13)	No delay	Automatic
ALA24		Suction pressure probe broken or disconnected. Suction pressure probe broken, disconnected or not properly configured	x		Shut off of LT/MT compressor (according to the setting made on mask Cag03)	No delay	Automatic
ALA25		Suction temperature probe broken or disconnected. Suction temperature probe broken, disconnected or not properly configured		x	No action on the regulation	No delay	Automatic
ALA43		gas cooler out temp.probe broken. Gas Cooler outlet temperature probe broken, disconnected or not properly configured	x		Shut off Gas Cooler 3way valve	No delay	Automatic
ALA55		Parallel line suction pressure probe broken or disconnected. Parallel suction pressure probe broken, disconnected or not properly configured		x	No action on the regulation Parallel Compressor will be shutted off by regulation	No delay	Automatic
ALA 56		Parallel line suction temperature probe broken or disconnected. Parallel suction temperature probe broken, disconnected or not properly configured		x	No action on the regulation	No delay	Automatic
ALA57		LT line discharge pressure probe broken or disconnected. LT discharge pressure probe broken, disconnected or not properly configured	x		Shut off LT compressor	No delay	Automatic
ALA58		LT line discharge temp probe broken or disconnected. LT discharge temperature probe broken, disconnected or not properly configured		x	No action	No delay	Automatic
ALB02		<b>GAS COOLER PRESSURE</b>	Common high condensing pressure switch alarm. High Pressure pressure switch (for Parallel/MT compressor). It is active when Gas Cooler pressure is higher than the pressure switch threshold	x		Shut off Parallel/MT compressor	Settable (by mask Hc01)

Mask index	Topic	Description	Serious alarm	Normal alarm	Action	Delay	Reset
ALB03		Low condensing pressure alarm. Gas Cooler pressure is lower than the threshold set in the mask De07	x		Shut off the Gas Cooler 3Way Valve	Settable (by mask De03)	Automatic
ALB04		High condensing pressure alarm. Gas Cooler pressure is higher than the threshold set in the mask De06	x		Forces Gas Cooler 3Way valve at 100%	Settable (by mask De01)	Automatic
ALB15	SUCTION PRESSURE	High suction pressure. Suction pressure higher than alarm threshold (settable by mask Cae24)		x	No action	Settable (by mask Cae25)	Automatic
ALB16		Low suction pressure. Suction pressure (read by probe) lower than the alarm threshold (settable by mask Cae26)		x	Shut off LT/MT compressor (settable by mask Cae27)	Settable (by mask Cae27)	Automatic
ALB21	GAS COOLER PRESSURE	Blocking alarm for high pressure prevent. When GC pressure rises above the prevent threshold the compressor speed is reduced up to switch off the compressor. The threshold is settable in mask Hb01	x		Decrease the compressor speed and after a delay Shut off the compressor	No delay	Automatic / manual
ALG01	GENERIC	Al_Clock. No communication between CPU and Internal clock		x	Disable all functions involving scheduler	No delay	---
ALG02		Extended memory error. Faulty controller	x		Shut off the unit	No delay	---
ALG03	EVAPORATORS	Unreliable condition because of no MPXPRO connected. The unit will switch OFF in xx hours. System shut off the unit when some controller for evaporators have been configured in fieldbus but they result off-line		x	Shut off the unit	---	---
ALT15	SUPERHEAT	Low shuperheat alarm. Low SH alarm settable by mask Cae30 (threshold and delay). A warning for Low SH will be issued without any delay		x	No action (by default). A compressor shut off can be configured by mask Cae30	Settable by mask Cae30	Automatic / manual (settable by mask Cae30)
ALT19		DSH Low liquid flowback. This alarm occurs when suction SH is lower than 0 K AND discharge SH (DSH) is lower than 10 K for a period higher than the one set in mask Cae41		x	Shut off compressor	Settable by mask Cae41	Automatic / manual (default)
ALT20	TRANSCRITICAL	HPV Valve position warning. HPV valve opening is higher that a threshold for a certain time (settable by mask Fhb30)		x	No action	Settable by mask Fhb30	Automatic
ALT17		Warning setpoint HPV. Gas cooler press.too low/high, different from current setpoint. Difference between Gas Cooler Pressure and HPV setpoint is greater than the threshold set on mask Fhb20 (disabled by default).		x	No action	Settable by mask Fhb20	Automatic
ALT18		High receiver pressure alarm. Receiver Pressure higher than		x	Shut off compressor (according to configuration)	Settable by mask Fhb28	Automatic

Mask index	Topic	Description	Serious alarm	Normal alarm	Action	Delay	Reset
		alarm threshold settable by mask Fhb28			made in mask Cbe42 and Fhb28)		
ALW10	<b>SUPERHEAT</b>	Warning low superheat. Suction SH of MT/LT compressor lower than alarm threshold (set on mask Cae30). No delay is used to issue the warning.		x	No action (it is just a warning)	No delay	Automatic
ALW24	<b>LT COMPRESSOR</b>	Power plus device offline. No communication between HECU controller and PSD (Inverter for compressor BLDC)	x		Shut Off compressor	No delay	Automatic
ALW25		Power+ inverter alarm. Generic Alarm of the PSD (LT/MT compressor). More details about the alarm code of the inverter is reported in the same mask.		x	Shut Off compressor	No delay	Automatic
ALW26		Compressor start failure. Delta Pressure between suction and discharge does not increase after the compressor start	x		Compressor shut off. Compressor restarts after a delay if this alarm does not occur more than 5 times in 60 minutes	Settable by mask Cag51	Automatic/manual (if it occurs more than 5 times in 60 minutes)
ALW27		Envelope alarm. Compressor is working out of admitted envelope. The current operating zone is reported in the same mask		x	Shut Off compressor	Settable by mask Cag55	Automatic
ALW28		High discharge gas temperature. Discharge temperature measured by the probe is higher than the Alarm threshold set on mask Hb02	x		Shut Off compressor	No delay	Automatic
ALW29		Compressor Low pressure differential (insufficient lubrication). Low delta pressure between suction pressure and discharge pressure		x	No Action	Settable by mask mask Cag55	Automatic
ALW30		Inverter model not compatible (Power+ only allowed). The inverter model is not compatible with the compressor size configured on mask Cag12		x	Compressor does not start	No delay	Automatic
ALP01		<b>PARALLEL COMPRESSOR</b>	Power + n.2 offline (Parallel Comp). No communication between HECU controller and PSD (Inverter for compressor BLDC) of Parallel Compressor		x	Shut Off Parallel compressor	No delay
ALP02	Alarm Power+ Parallel Compressor. Generic Alarm of the PSD (Parallel compressor). More details about the alarm code of the inverter is reported in the same mask.			x	Shut Off Parallel compressor	No delay	Automatic
ALP03	Parallel compressor start failure. Delta Pressure between suction and discharge does not increase after the compressor start		x		Compressor shut off. Compressor restarts after a delay if this alarm does not occur more than 5 times in 60 minutes	Settable by mask Cbg51	Automatic/manual (if it occurs more than 5 times in

Mask index	Topic	Description	Serious alarm	Normal alarm	Action	Delay	Reset
							60 minutes)
ALP04		Parallel compressor envelop alarm. Compressor is working out of admitted envelope. The current operating zone is reported in the same mask		x	Shut Off Parallel compressor	Settable by mask Cbg55	Automatic
ALP05		Parallel compressor high discharge gas temperature. Discharge temperature measured by the probe is higher than the Alarm threshold set on mask Cag57		x	Shut Off Parallel compressor	No delay	Automatic
ALP06		Parallel compressor low pressure differential (insufficient lubrication). The pressure difference between suction and discharge of parallel compressor is too low.		x	Compressor Shut off	Settable by mask Cbg55	Automatic
ALP07		Parallel compressor inverter model not compatible (power+ only allowed). The inverter model is not compatible with the compressor size configured on mask Cag12		x	Parallel compressor does not start	No delay	Automatic
ALW40-53-66-79-92	EVAPORATORS	Store number: !! OFFLINE !!	x		- Not present R2 2		
ALW41-54-67-80-93		Store number: Low temperature alarm [Generic Probe 1]		x	Display only (refer to MPXPRO / Ultracella user manual)		
ALW42-55-68-81-94		Store number: High temperature alarm [Generic Probe 1]		x	Display only (refer to MPXPRO / Ultracella user manual)		
ALW43-56-69-82-95		Store number: Low temperature alarm [Generic Probe 2]		x	Display only (refer to MPXPRO / Ultracella user manual)		
ALW44-57-70-83-96		Store number: High temperature alarm [Generic Probe 2]		x	Display only (refer to MPXPRO / Ultracella user manual)		
ALW45-58-71-84-97		Store number: Defrost timeout		x	Display only (refer to MPXPRO / Ultracella user manual)		
ALW46-59-72-85-98		Store number: Low superheat alarm		x	Display only (refer to MPXPRO / Ultracella user manual)		
ALW47-60-73-86-99		Store number: Low suction temp.alarm		x	Display only (refer to MPXPRO / Ultracella user manual)		
ALW48-61-74-87-ALZ00		Store number: MOP alarm		x	Display only (refer to MPXPRO / Ultracella user manual)		
ALW49-62-75-88-ALZ01		Store number: LOP alarm		x	Display only (refer to MPXPRO / Ultracella user manual)		

Mask index	Topic	Description	Serious alarm	Normal alarm	Action	Delay	Reset
ALW50-63-76-89-ALZ02		Store number: Stepper driver communication error		x	Display only (refer to MPXPRO / Ultracella user manual)		
ALW51-64-77-90-ALZ03		Store number: Stepper motor error		x	Display only (refer to MPXPRO / Ultracella user manual)		
ALW52-65-78-91-ALZ04		Store number: Installation or config problems on EEV driver		x	Display only (refer to MPXPRO / Ultracella user manual)		

## 11.2 PSD (Power+) alarm code

In the below table we reported a quick description about the PSD alarm code could occur in the unit with the possible causes and solutions.

The PSD (Power+) alarm code is reported in the alarm masks or in the alarm logs (please find an example in the below picture).

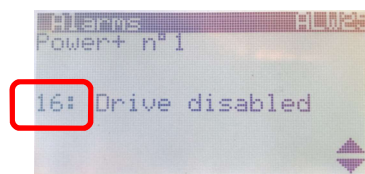

Alarm code	Description	Possible cause	Solutions
0	No alarm	-	-
1	Overcurrent	The drive has detected a current supplied that is too high due to: - sudden strong load increase; - acceleration that is too high; - wrong parameters values or inadequate motor.	Check the load, the dimension of the motor and the cables. Decrease acceleration. Check the motor parameters..
2	Motor overload	The current supplied has exceeded the motor rated current over the maximum time accepted	Check the load, the dimension of the motor and the cables. Check the motor parameters.
3	Overvoltage	The DC voltage of the intermediate circuit has exceeded the limits envisioned due to: - deceleration that is too high; - high over-voltage peaks on the power supply network.	Decrease deceleration.
4	Undervoltage	The DC voltage of the intermediate circuit is below the limits envisioned due to: - insufficient power supply voltage; - fault inside the drive.	In the event of temporary cut-off of the power supply, reset the alarm and re-start the drive. Check the power supply voltage.
5	Drive overtemperature	The temperature inside the drive has exceeded the maximum level allowed.	Check that the quantity and flow of cooling air are regular. Check that there is not dust in the heat sink. Check the environment temperature. Ensure that the switching frequency is not too high with respect to the environment temperature and the motor load.
6	Drive undertemperature	The temperature of the drive is inferior to the minimum level allowed.	Warm up the ambient where the drive is installed.
7	Overcurrent HW	The drive has detected an instantaneous current supplied that is too high due to: - sudden strong load increase; - motor cables short circuit;	Check the load, the dimension of the motor and the cables. Check the motor parameters.

Alarm code	Description	Possible cause	Solutions
		- wrong parameters values or inadequate motor.	
8	<b>Motor overtemperature</b>	The temperature detected by the PTC thermistor corresponds to a resistance > 2600 ohm.	Reduce the motor load. Check motor cooling.
9	<b>Reserved (for future use)</b>		
10	<b>CPU error</b>	Loss of data in memory	Call for assistance
11	<b>Parameter default</b>	Execution of reset parameter default command; Parameters user setting corrupted	Set parameters again
12	<b>DCbus ripple</b>	Input power supply phase loss, three-phase power supply unbalance	Check the input power supply phases to the drive, reduce motor power (speed)
13	<b>Data communication fault</b>	Data reception failure	Check the serial connection. Switch the drive off and back on again.
14	<b>Drive thermistor fault</b>	Internal fault	Call for assistance
15	<b>Autotuning fault</b>	Wrong parameter values	Check the parameter values Restart the command again
16	<b>Driver disabled (STO input open or de-energized)</b>	Cable disconnected Operation of external contactor 24V power supply loss	Check the wiring. Restore external contactor
17	<b>Motor phase fault (**)</b>	Motor cable disconnected	Check the connections of the motor cable
18	<b>Reserved (for future use)</b>		
19	<b>Speed fault</b>	Wrong parameters values or unsuited load	Switch the drive off and back on again and check the parameters are properly set. Check the motor load.
20	<b>PFC module error</b>	PFC overcurrent	Call for assistance
21	<b>Power supply overvoltage</b>	Too high power supply voltage	Check input power supply and if inductive load generating overvoltage are connected to the line
22	<b>Power supply undervoltage</b>	Too low power supply voltage	Check input power supply
23	<b>STO detection error</b>	Internal fault	Call for assistance
24	<b>Reserved (for future use)</b>		
25	<b>Ground fault</b>	The drive has detected a ground current too high	Check ground insulation of the motor and wires .
26	<b>CPU sync error 1</b>	Overload CPU	Call for assistance
27	<b>CPU sync error 2</b>	Loss of data in memory	Call for assistance
28	<b>Drive overload</b>	The current supplied has exceeded the drive rated current over the maximum time accepted	Check the load, the dimension of the motor and the cables. Check the motor parameters.

Alarm code	Description	Possible cause	Solutions
99	<b>Overload Alarm</b>	This alarm occurs when there is a misalignment between the RUN command provide by the controller and the internal status of PSD (that is in OFF)	Check power supply stability (this behaviour can happen if there are some undervoltage peak in the main power supply).

### 11.3 PSD led status

In case of PSD alarm, could be useful to check also the led status directly in the PSD.

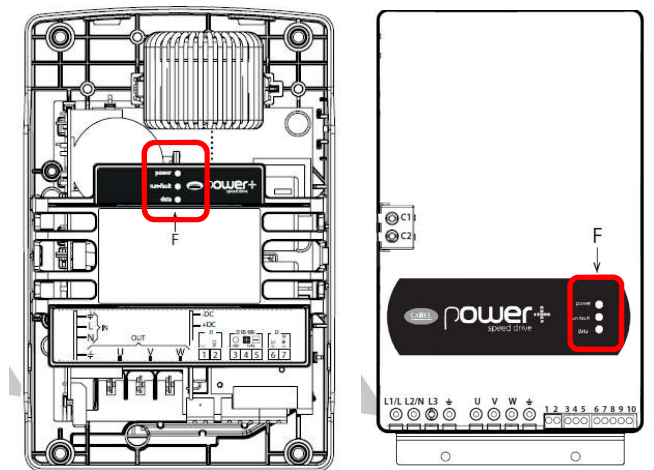

Led	Status/color	Description
Power	green	drive powered
RUN/Fault	green	drive is running
	red	fault
DATA	yellow	communication active



## 12 Troubleshooting

Symptom/alarm	Possible Cause	Check
Probes alarm/ wrong reading	<ul style="list-style-type: none"> <li>- wrong connection</li> <li>- wrong configuration</li> <li>- wrong range (for pressure probe)</li> <li>- wrong type of probe</li> <li>- wrong placement of probe</li> <li>- broken probe</li> </ul>	Check the connection and the configuration of the probe: <ul style="list-style-type: none"> <li>- type of probe</li> <li>- wirings</li> <li>- probes range (min and max)</li> <li>- compare the value read by the probe with the value read by a manometer</li> </ul>
Missing communication between Hecu and PSD (power+/Inverter)/ ALP01/ ALW24	<ul style="list-style-type: none"> <li>-Power plus device offline.</li> <li>-No communication between HECU controller and PSD (Inverter for compressor BLDC)</li> </ul>	<ul style="list-style-type: none"> <li>- check the PSD power supply (it must be powered)</li> <li>- check the RS485 wiring between HECU and PSD</li> <li>- check the serial address set in the PSD (dip switch configuration)</li> <li>-check the PSD address set in the HECU controller</li> </ul>
LT compressor does not start	<ul style="list-style-type: none"> <li>- Some blocking alarm is forcing off the compressor</li> <li>- Regulation status of the unit is OFF</li> <li>- Most of evaporators are performing a defrost (only if evaporators controller are connected to the CDU via RS485)</li> <li>- Wrong configuration of PSD (power+ driver)</li> </ul>	<ul style="list-style-type: none"> <li>- Check the active alarm and try to reset the alarm (consulting the alarms table suggestions)</li> <li>- Switch ON the unit</li> <li>- Check the Defrost setting on mask FBB15 (only if evaporators controller are connected to the CDU via RS485)</li> <li>- Force the download settings from Hecu Controller to PSD</li> </ul>
Parallel compressor does not start	<ul style="list-style-type: none"> <li>- Some blocking alarm is forcing off the compressor</li> <li>-Regulation status of the unit is OFF</li> <li>-The LT compressor is OFF</li> <li>- Wrong configuration of PSD (power+ driver)</li> </ul>	<ul style="list-style-type: none"> <li>- Check the active alarm and try to reset the alarm (consulting the alarms table suggestions)</li> <li>- Switch ON the unit</li> <li>- Check the configuration of DSS (Fib05)</li> <li>- Force the download settings from Hecu Controller to PSD</li> </ul>
Missing communication between Hecu and evaporators (MPXPRO/ULTRACELLA)/ ALW37	<ul style="list-style-type: none"> <li>- Wrong connection of serial line</li> <li>- Wrong serial address setting</li> </ul>	<ul style="list-style-type: none"> <li>- Check the RS485 wirings/connection</li> <li>- Check the serial address set in the evaporator controller</li> <li>- Check the protocol and baudrate (Modbus, 19200bps)</li> </ul>
Low SH alarm or DSH alarm (ALW10/ ALT15/ ALT15)	<ul style="list-style-type: none"> <li>- Liquid is coming back to the compressor</li> <li>- Wrong reading of SH probes (temp. and pressure)</li> <li>- Wrong reading of discharge temp probe</li> </ul>	<ul style="list-style-type: none"> <li>- Check the SH in the evaporator</li> <li>- Check the right operation of Expansion valve in the evaporator</li> <li>- Check the position of the probe and be sure they are reading properly</li> <li>- (for MT Comp or Parallel comp) check that liquid is not coming back from RPRV valve. This can happen in case of an overcharge of refrigerant</li> </ul>

### 13 Compressor Envelope

Compressor envelope zone consists in the safety area (Suction/discharge pressure) where compressor is allowed to run without problem.

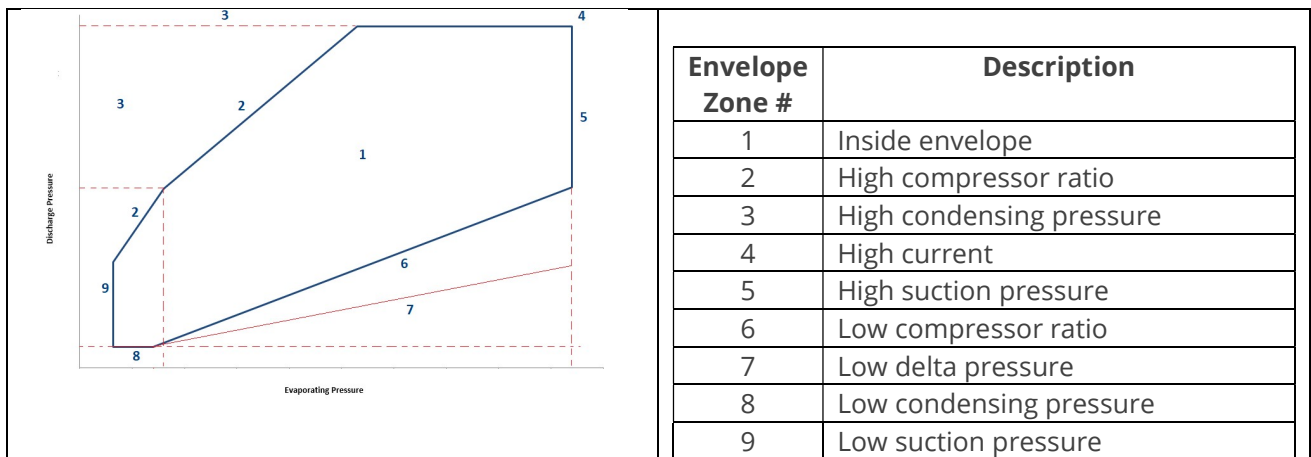
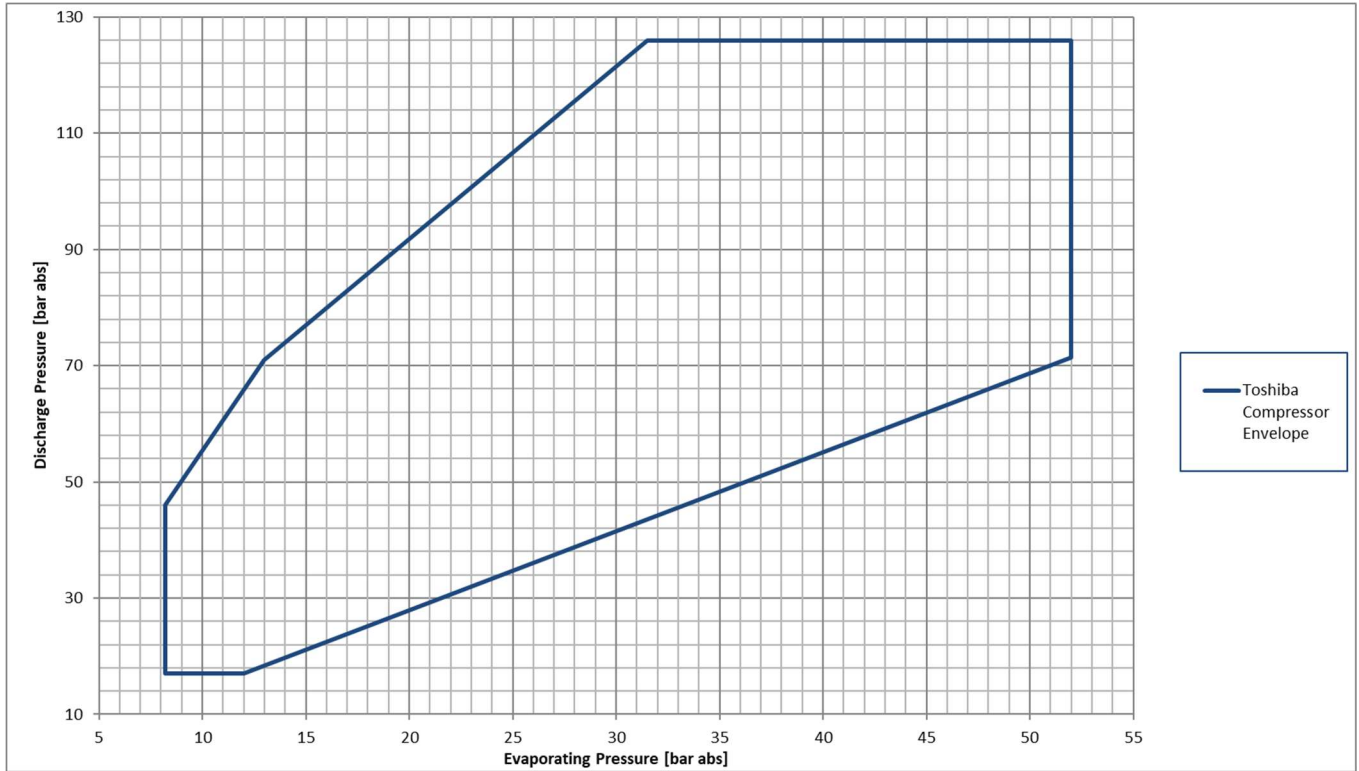

## 14 Refrigerant drawing (P&I)

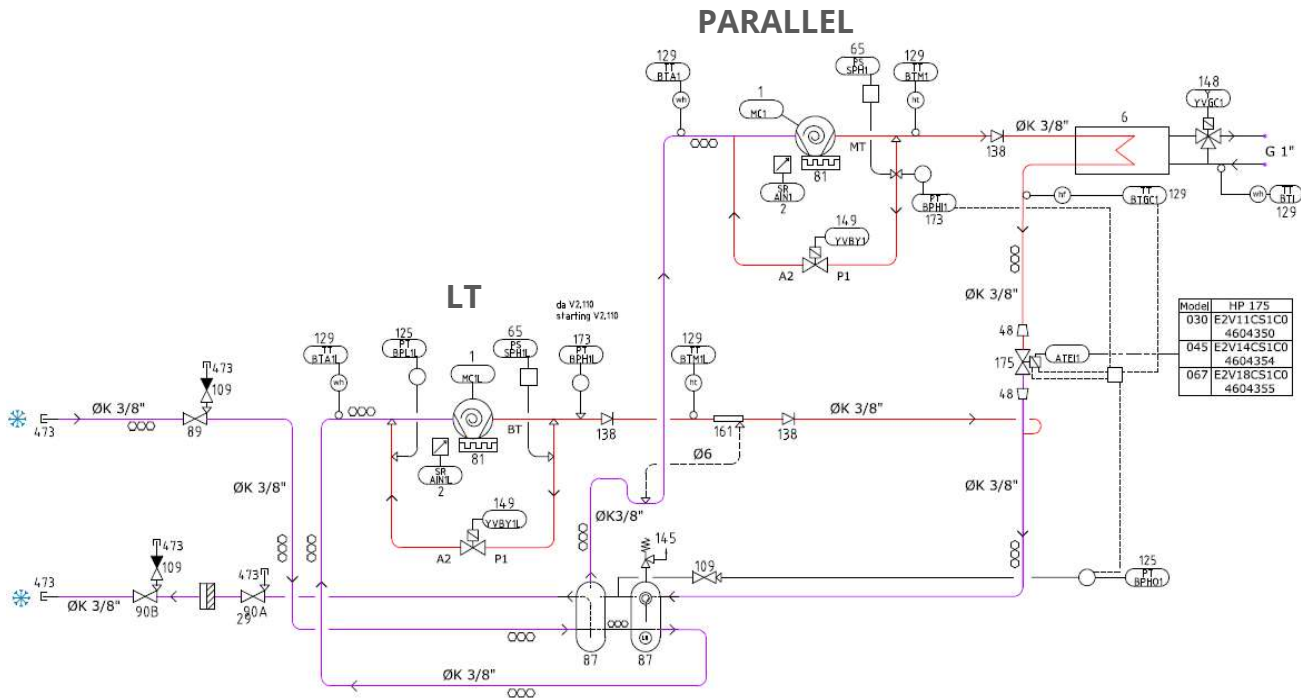

Pos.	Ref.	Description	Note 1	Note 2
1	1 (MC1L)	Rotary Compressor LT		
2	1 (MC1)	Rotary Compressor Paral.		
3	2 (AIN1L)	Inverter LT		
4	2 (AIN1)	Inverter Paral.		
5	6	Gas Cooler PHE		
6	148	3 Way Valve		
7	29	Refrigerant filter Dryer		
8	65 (SPH1L)	HP safety switch LT		
9	65 (SPH1)	HP safety switch Paral.		
10	81	Crankcase heating		
11	87	2x Liquid receivers (parallel)		
12	89	Suction shut-off valve		
13	90A	Liquid shut-off valve (upstream 29)		
14	90B	Liquid shut-off valve		
15	109	Service valve (diff. models)		
16	125 (BP1L)	Low pres. transd. LT / Regulation		
17	125 (BPHO1)	Low pres. transd. Paral. / Receiver		
18	129 (BTA1L)	Comp. Suction temp. probe LT		
19	129 (BTAO1)	Comp. Suction temp. probe Paral.		
20	129 (BTM1)	Comp. Discharge temp. probe Paral.		
21	129 (BTE1)	Water-In temperature probe		
22	129 (BTGC1)	GC outlet temp. probe		
23	138	Check valve		
24	145	Pressure Relief Valve		
25	149 (YVBY1L)	By-pass solenoid valve LT		
26	149 (YVBY1)	By-pass solenoid valve Paral.		
27	161	Oil separator		
28	173 (BPH1)	Discharge pressure transd. Paral		
29	173 (BPH1L)	Discharge pressure transd. LT (option)		
30	175 (ATEI1)	High Pressure Valve (HPV)		
31	473	Service outlet		

## 15 HECU Controller layout

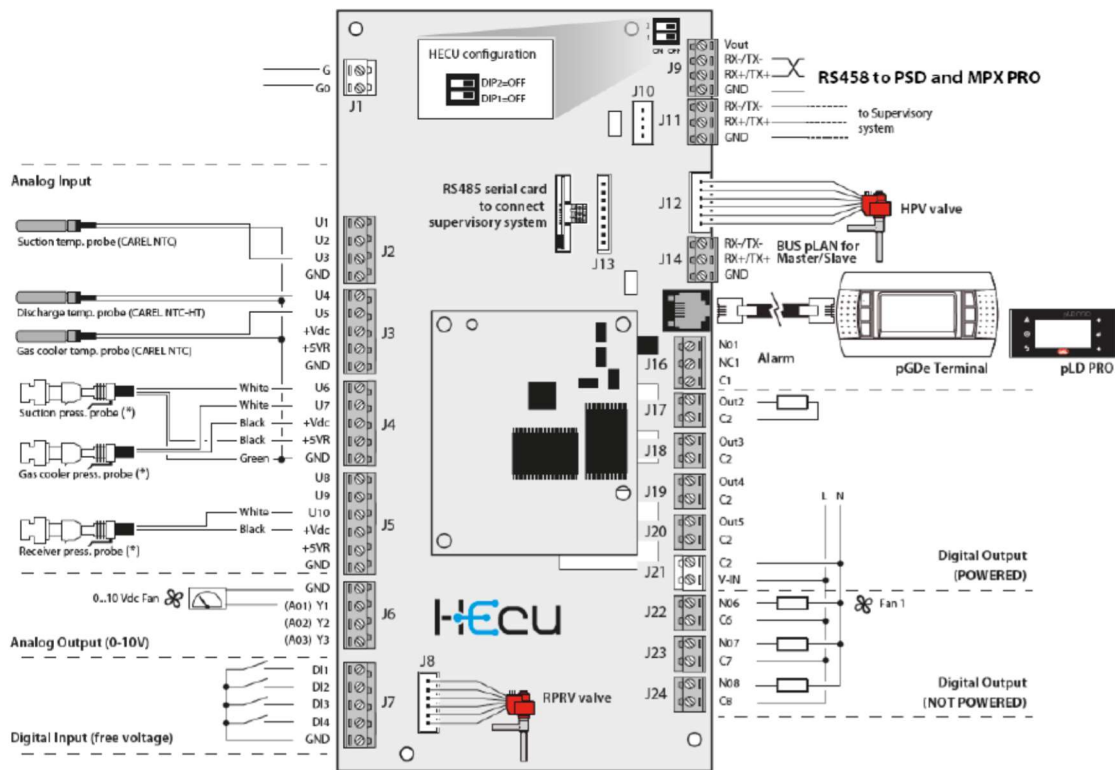

Analog Inputs		Digital Inputs		Analog Output		Digital Output	
U1	Discharge temp. LT	DI1	ON/OFF remote	Y1	Modulating Valve (Water In GC)	NO1-C1	Serious alarm
U2	Ambient temperature (Water-In temp)	DI2	High pressostat alarm	Y2	-	NO2-C2	By-pass solenoid valve Paral
U3	Suction temp. Paral.	DI3	Evaporator Request	Y3	-	NO3-C3	By-pass solenoid valve LT
U4	Discharge temp. LT	DI4	Change Setpoint			NO4-C4	-
U5	Gas Cooler Outlet temp.	DI5				NO5-C5	-
U6	Discharge pres. LT (Option)					NO6-C6	-
U7	Discharge pres. Trans. Paral					NO7-C7	Compressor Ready
U8	Suction temp. LT					NO8-C8	Cabinet washing
U9	Suction pres. LT comp						
U10	Suction pres. Paral. Comp./Receiver						

## 16 Terminals blocks connection

<ul style="list-style-type: none"> <li>☑ BMS serial connection, use terminal blocks: R-; R+; G.</li> <li>☑ On/off remote, use terminal blocks: DI1; GND3 (Remove bridge also present).</li> <li>☑ Remote digital alarm, use terminal blocks: NO1; C (closed in case of alarm).</li> <li>☑ CAREL Remote evap. lan, use terminal blocks: Rx-; Rx+; REF.</li> <li>☑ Adiabatic ramp power supply, use terminal blocks: L30; N30; PE.</li> </ul>	
---	--

## 17 Dimensional drawing

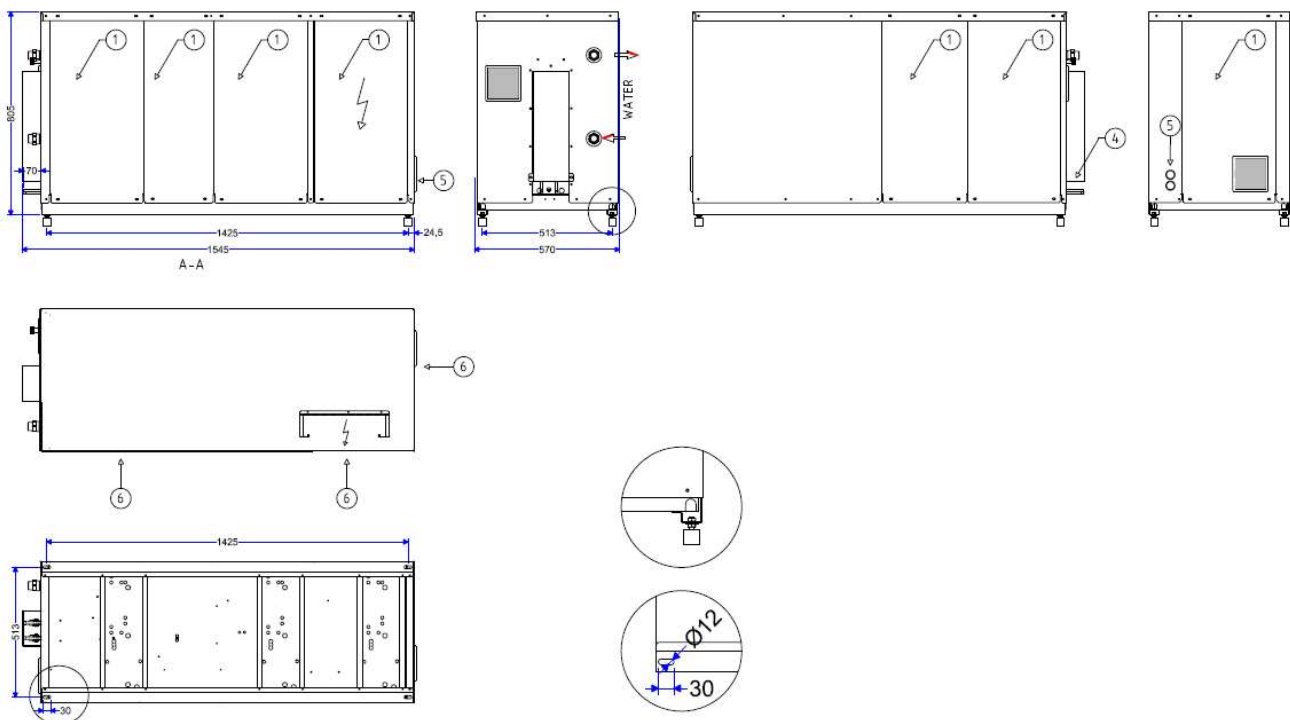

## 18 General information and limits

General Characteristics				
Cubo2 AQUA line models	UMT/WG T 030 BT DX	UMT/WG T 045 BT DX	UMT/WG T 067 BT DX	
Compressor Motor	Refrigerant	R744 (CO <sub>2</sub> )		
	Toshiba Rotary Compressors	1x DY30N1F-10FU - BT 1x DY30N1F-10FU - Paral.	1x DY45N1F-10FU BT 1x DY45N1F-10FU Paral.	1x DY67L1F-10FU - BT 1x DY67L1F-10FU - Paral.
	Number of cylinders	1	1	2
	Number of poles	4		
	Moto type	DC Brushless		
	Revolution range	25 ≈ 100 rps	25 ≈ 100 rps	25 ≈ 100 rps
	Oil charged per Rotary Compressor	520 ml	520 ml	450 ml
	Oil type	PAG VG100		
	Discharge pressure	125 bar max	125 bar max	125 bar max
	Suction pressure	12 ≈ 41 bar	12 ≈ 41 bar	12 ≈ 41 bar
	Evaporating temp.	-30 °C ≈ -20 °C		
	Susction Superheating	10 K ≈ 20 K		
	System	Discharge temperature	max 130 °C	
Ambient temp.		-15 °C ≈ +40 °C		
		-20 °C only with winter kit option		
Water Inlet temp.		+7 °C ≈ +37 °C		
Receiver		2x 2,4 lt (2,4 lt Receiver max charge)		
Suction line		3/8" K65 (9,52mm)	3/8" K65 (9,52mm)	3/8" K65 (9,52mm)
Liquid line		3/8" K65 (9,52mm)	3/8" K65 (9,52mm)	3/8" K65 (9,52mm)
PS Suction / Liquid	80 bar / 80 bar			
PED Category	I			
Generic	Dimensions (A x B x H)	1545 x 570 x 805 mm		
	Trasport dimensions (A x B x H)	1650 x 650 x 950 mm		
	(Net) Gross weight	(176 Kg) 194 Kg		
	Transport way	Pallet & Carton		
	Painted	RAL 7035		
Sound level (max speed) <sup>1)</sup>	41 dBA	41 dBA	42 dBA	

<sup>1)</sup> Sound pressure and sound power analytically calculated. Sound pressure level at 10 m in free field.

## 19 Electrical details

Electrical Information			
Cubo2 AQUA line Size	UMT/WG T 030 BT DX	UMT/WG T 045 BT DX	UMT/WG T 067 BT DX
Power Suply	230V/1Ph+N+PE/50Hz		400V/3Ph+N+PE/50Hz
Recommended protection	Circuit Breaker C 16 A	Circuit Breaker C 25 A	Circuit Breaker C 25 A
MRA	13,9 A	20,7 A	20,4 A
P abs max	3190 W	4760 W	7065 W
MRA = Maximum Rated Abs.			

- ☑ Unit is made in accordance with EN-60204-1. All electrical cabling, in external unit, have been made in accordance with EN-60204-1.  
All connection must be done by qualified persons according to legal standards in force in the relevant countries and to EN-60204-1. Supply cable must be connected on terminal of upstream main switch. Connect wire of ground (PE), from specific terminal block to system protection.

## 20 Cooling capacity Table

UMTT 030 BTDX [Tentative Data]					
Cooling Capacity [W] SC:0 K - SH:10 K					
Min speed		Evaporating SST			
		-35	-30	-25	-20
	T <sub>water_in</sub> °C	11,0	13,3	15,8	18,7
	40				
	37		603	737	787
	32		652	760	840
	29		652	760	840
	25		652	760	840
	20		652	760	840
	15		652	760	840
	5				TBD

Max speed		Evaporating SST			
		-35	-30	-25	-20
	T <sub>water_in</sub> °C	11,0	13,3	15,8	18,7
	40				
	37		3112	3556	3652
	32		3343	3662	3904
	29		3343	3662	3904
	25		3343	3662	3904
	20		3343	3662	3904
	15		3343	3662	3904
	5		3343	3662	3904

UMTT 045 BTDX [Tentative Data]					
Cooling Capacity [W] SC:0 K - SH:10 K					
Min speed		Evaporating SST			
		-35	-30	-25	-20
	T <sub>water_in</sub> °C	11,0	13,3	15,8	18,7
	40				
	37		943	1054	1157
	32		984	1105	1227
	29		984	1105	1227
	25		984	1105	1227
	20		984	1105	1227
	15		984	1105	1227
	5		984	1105	1227

Max speed		Evaporating SST			
		-35	-30	-25	-20
	T <sub>water_in</sub> °C	11,0	13,3	15,8	18,7
	40				
	37		4852	5127	5563
	32		5049	5331	5700
	29		5049	5331	5700
	25		5049	5331	5700
	20		5049	5331	5700
	15		5049	5331	5700
	5		5049	5331	5700

UMTT 67 BTDX [Tentative Data]		Cooling Capacity [W] SC:0 K - SH:10 K			
Min speed		Evaporating SST			
		-35	-30	-25	-20
	T <sub>water_in</sub> °C	11,0	13,3	15,8	18,7
	40				
	37		1607	1788	-
	32		1677	1860	2002
	29		1677	1860	2002
	25		1677	1860	2002
	20		1677	1860	2002
	15		1677	1860	2002
	5		1677	1860	2002

Max speed		Evaporating SST			
		-35	-30	-25	-20
			T <sub>water_in</sub> °C	11,0	13,3
	40				
	37		6339	7002	-
	32		6599	7268	7797
	29		6599	7268	7797
	25		6599	7268	7797
	20		6599	7268	7797
	15		6599	7268	7797
	5		6599	7268	7797



## 21 Conversion pressure-temperature CO<sub>2</sub> (R744)

Temperature		Pressure	
(°C)	(°F)	(Bar-abs)	(psig)
-50.0	-58.0	6.8	84
-49.0	-56.2	7.1	88
-48.0	-54.4	7.4	93
-47.0	-52.6	7.7	97
-46.0	-50.8	8.0	101
-45.0	-49.0	8.3	106
-44.0	-47.2	8.6	111
-43.0	-45.4	9.0	116
-42.0	-43.6	9.3	121
-41.0	-41.8	9.7	126
-40.0	-40.0	10.0	131
-39.0	-38.2	10.4	136
-38.0	-36.4	10.8	142
-37.0	-34.6	11.2	148
-36.0	-32.8	11.6	154
-35.0	-31.0	12.0	160
-34.0	-29.2	12.5	166
-33.0	-27.4	12.9	172
-32.0	-25.6	13.3	179
-31.0	-23.8	13.8	185
-30.0	-22.0	14.3	192
-29.0	-20.2	14.8	199
-28.0	-18.4	15.3	207
-27.0	-16.6	15.8	214
-26.0	-14.8	16.3	222
-25.0	-13.0	16.8	229
-24.0	-11.2	17.4	237
-23.0	-9.4	17.9	245
-22.0	-7.6	18.5	254
-21.0	-5.8	19.1	262
-20.0	-4.0	19.7	271
-19.0	-2.2	20.3	280
-18.0	-0.4	20.9	289
-17.0	1.4	21.6	298
-16.0	3.2	22.2	308
-15.0	5.0	22.9	317
-14.0	6.8	23.6	327
-13.0	8.6	24.3	338
-12.0	10.4	25.0	348
-11.0	12.2	25.7	359
-10.0	14.0	26.5	369

Temperature		Pressure	
(°C)	(°F)	(Bar-abs)	(psig)
-9.0	15.8	27.2	380
-8.0	17.6	28.0	392
-7.0	19.4	28.8	403
-6.0	21.2	29.6	415
-5.0	23.0	30.5	427
-4.0	24.8	31.3	439
-3.0	26.6	32.2	452
-2.0	28.4	33.0	464
-1.0	30.2	33.9	477
0.0	32.0	34.9	491
1.0	33.8	35.8	504
2.0	35.6	36.7	518
3.0	37.4	37.7	532
4.0	39.2	38.7	546
5.0	41.0	39.7	561
6.0	42.8	40.7	576
7.0	44.6	41.8	591
8.0	46.4	42.8	606
9.0	48.2	43.9	622
10.0	50.0	45.0	638
11.0	51.8	46.1	654
12.0	53.6	47.3	671
13.0	55.4	48.5	688
14.0	57.2	49.7	705
15.0	59.0	50.9	723
16.0	60.8	52.1	741
17.0	62.6	53.4	759
18.0	64.4	54.7	778
19.0	66.2	56.0	797
20.0	68.0	57.3	816
21.0	69.8	58.6	836
22.0	71.6	60.0	856
23.0	73.4	61.4	876
24.0	75.2	62.9	897
25.0	77.0	64.3	918
26.0	78.8	65.8	940
27.0	80.6	67.4	962
28.0	82.4	68.9	985
29.0	84.2	70.5	1008
30.0	86.0	72.1	1031
30.9	87.6	73.6	1053





- SCM reserves possibility to modify or to change at present, without prevent notice.
- Documentation produced by SCM, is intended as guide for installation.
- The installer is responsible for verify, certifications, design, installation unit and all present systems.
- SCM Frigo is not responsible for any malfunction in the system due by the unit and/or system design and/or installation problems.
- SCM Frigo will not be responsible for operation unit or any system present, if above specific are not respected.



[www.scmfrigo.com](http://www.scmfrigo.com)

